

MEMS Ultra-Mini 1x2 Reflection Fiber Optical Switch

Non-Latching Type, SM & MM: 1x1, 1x2



DATASHEET

[Return to the Webpage](#)



Features

- High Reliability
- Direct DC drive
- Ultra Small
- Intrinsic tolerance to ESD

The MEMS Series Ultra-Mini 1x2 Reflective Fiber Optical Switch connects optical channels by redirecting incoming optical signals into selected output fibers. This is achieved by using a proprietary thermal activated micro-mirror, moving-in and -out optical paths, uniquely featuring high stability over wide temperature range without compensation, small size and very long life cycle. The ultra-mini Reflective switches are configured in 1x1 and 1x2 with single or multimode fibers. The Ultra-Mini switches are Telcordia standards GR1221 qualified.

Agiltron provides customized design and modular assemblies to meet control and integration applications.

Specifications

Parameter		Min	Typical	Max	Unit
Operation Wavelength	Single Mode	1260~1360 and / or 1510~1610			nm
	Multimode	810~890 and/or 1260/1360			
Insertion Loss ^{[1], [2]}			0.6	1.0 / 1.2 ^[3]	dB
Polarization Dependent Loss (SM)				0.1	dB
Return Loss ^[1]	Single Mode	50			dB
	Multimode	35			
Cross Talk On-Off Ratio ^[1]	Single Mode	50			dB
	Multimode	35			
Switching Time			10		ms
Repeatability				±0.05	dB
Repetition Rate				20	Hz
Durability		10 ⁹			Cycle
Switching Type		Non-Latching			
Optical Power Handling (CW)			300	500	mW
Operating Temperature ^[4]		-5		+70	°C
Storage Temperature		-40		+85	°C
Fiber Type	Single Mode	SMF-28 or equivalent			
	Multimode	MM 50/125, MM 62.5/125 or equivalent			

Notes:

- [1]. Excluding connectors.
- [2]. Multimode IL measured @ Light Source CPR < 14dB.
- [3]. Dual band, Broad band.
- [4]. Lower temperature version is available, please call us.

Note: The specifications provided are for general applications with a cost-effective approach. If you need to narrow or expand the tolerance, coverage, limit, or qualifications, please [click this link](#):

Legal notices: All product information is believed to be accurate and is subject to change without notice. Information contained herein shall legally bind Agiltron only if it is specifically incorporated into the terms and conditions of a sales agreement. Some specific combinations of options may not be available. The user assumes all risks and liability whatsoever in connection with the use of a product or its application.

Rev 04/25/25

MEMS Ultra-Mini 1x2 Reflection Fiber Optical Switch



Non-Latching Type, SM & MM: 1x1, 1x2

DATASHEET

Mechanical Dimensions (mm)

Package 1: For bare fibers version.

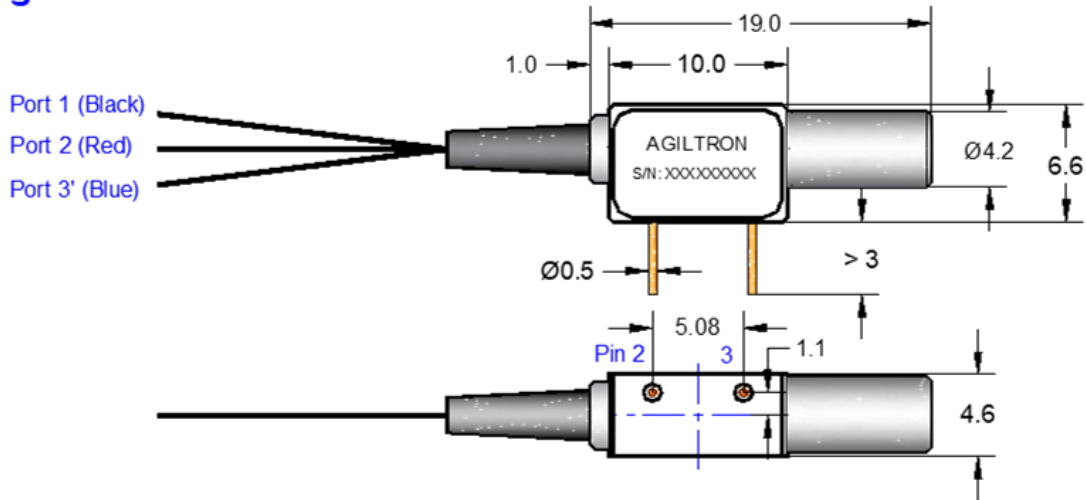

Package 2: For 900 um loose tube version.

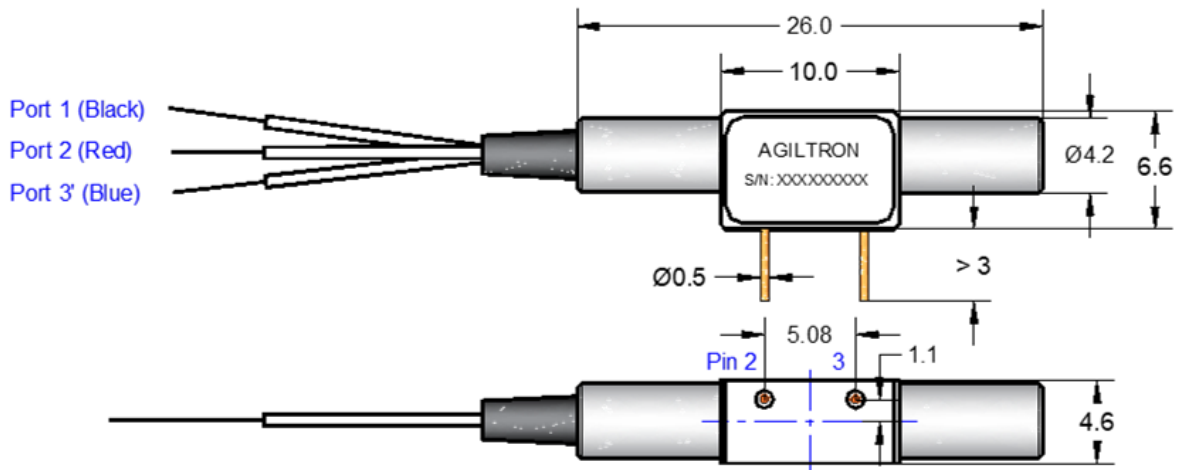

*Product dimensions may change without notice. This is sometimes required for non-standard specifications.

Electrical Driving Requirements

Status	Switch Type			Pin No.	
	1x1 (Normally Transparent)	1X1 (Normally opaque)	1x2	Pin 2	Pin 3
Status 1	Bright	Dark	Port 1 → 2	0	0
Status 2	Dark	Bright	Port 1 → 3	0	+V [2]

[1]. NC: No electronic Connection. [2]. +V: 3.8 ~ 4.5 VDC, Typical is 4.0 VDC. [3]. Power Consumption is about 170 mW.

MEMS Ultra-Mini 1x2 Reflection Fiber Optical Switch



Non-Latching Type, SM & MM: 1x1, 1x2

DATASHEET

Mechanical Dimensions (mm)

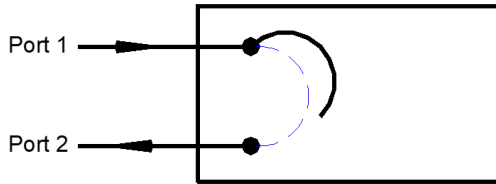

1x1 Reflection

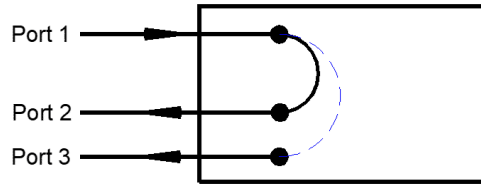

1x2 Reflection

Ordering Information

Prefix	Type	Wavelength*	Configuration	Package	Fiber Type	Fiber Cover	Fiber Length	Connector
MIRS- ^[1]	1x1 N/T ^[2] = 1T 1x1 N/D ^[3] = 1D 1x2 = 12	1060 nm = 1 1310 nm = 3 1550 nm = 5 780 nm = 7 850 nm = 8 1310/1550 nm = 9 850/1310 nm = A 1260~1620 nm = B Special = 0	Non-latching = 2	Standard = 1	SMF-28 = 1 MM 50/125 = 2 MM 62.5/125 = 6 Special = 0	Bare fiber = 1 900 um tube = 3 Special = 0	0.25m = 1 0.5m = 2 1.0m = 3 Special = 0	None = 1 FC/PC = 2 FC/APC = 3 SC/PC = 4 SC/APC = 5 ST/PC = 6 LC/PC = 7 Duplex LC/PC = 8 LC/APC = A LC/UPC = U Special = 0

[1]. MIRS: MEMS Ultra-Mini Reflective Switch.

[2]. N/T: 1x1 Switch, Normally Transparency.

[3]. N/D: 1x1 Switch, Normally Dark.

Application Notes

Fiber Core Alignment

Note that the minimum attenuation for these devices depends on excellent core-to-core alignment when the connectors are mated. This is crucial for shorter wavelengths with smaller fiber core diameters that can increase the loss of many decibels above the specification if they are not perfectly aligned. Different vendors' connectors may not mate well with each other, especially for angled APC.

Fiber Cleanliness

Fibers with smaller core diameters (<5 μm) must be kept extremely clean, contamination at fiber-fiber interfaces, combined with the high optical power density, can lead to significant optical damage. This type of damage usually requires re-polishing or replacement of the connector.

Maximum Optical Input Power

Due to their small fiber core diameters for short wavelength and high photon energies, the damage thresholds for device is substantially reduced than the common 1550nm fiber. To avoid damage to the exposed fiber end faces and internal components, the optical input power should never exceed 20 mW for wavelengths shorter 650nm. We produce a special version to increase the how handling by expanding the core side at the fiber ends.

MEMS Ultra-Mini 1x2 Reflection Fiber Optical Switch



Non-Latching Type, SM & MM: 1x1, 1x2

DATASHEET

Recommendation Control Circuit

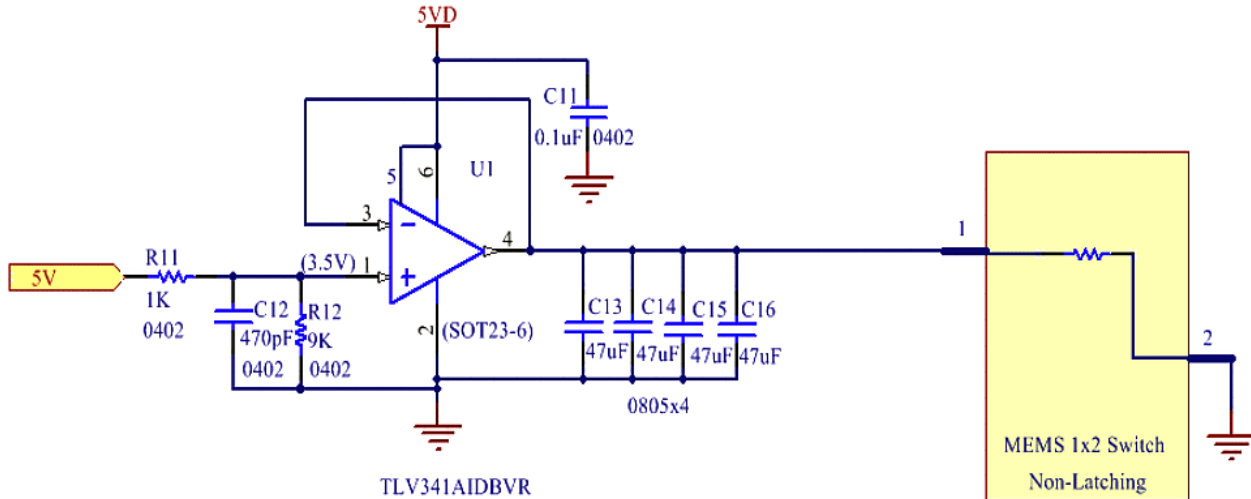

Note:
adjust R12 to match 3.5V at pin 1

MEMS 1X1 Switch Response Time Test Report

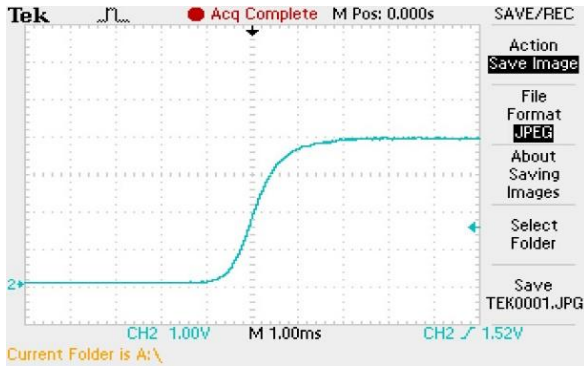

Switch Time (Rise): 1.64 ms

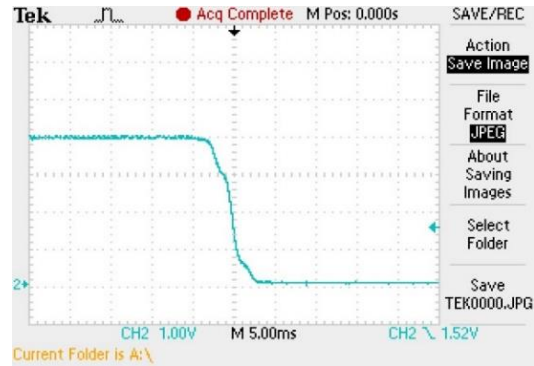

Switch Time (Fall): 5.4 ms



Working at 1 Hz